

RO Drinking Water System Installation Guide & Owner's Manual



AAA-RO50W
AAA-RO100W

wateranywhere.com[®]

About Your RO Water Treatment System

Thank you for your purchase of the WaterAnywhere home RO reverse osmosis water treatment system. This drinking water system has been designed for quick and simple installation and maintenance. By carefully reading this instruction manual and following the operational guidelines you will ensure a successful installation and reliable operation. Routine maintenance is essential to the longevity and performance of the system. Filters should be changed every three to six months depending on the quality of the feed water supply.

⚠ Notice: *Please read this entire service guide prior to beginning installation.*

5 Stages of Water Treatment

Stage 1: Sediment Filter Cartridge

Replace every 3-6 months

The first filter the water passes through is a five micron filter cartridge. This cartridge removes sediment including dirt, sand, rust, grit, and other suspended matter from water. This protects the rest of the filtration stages and equipment from damage and clogging due to buildup of sediment.

Stage 2 & 3: Carbon Block Filter Cartridges

Replace every 3-6 months

Next, the water passes through two stages of carbon filters to remove chlorine and objectionable tastes and odors from water. These filters also protect the membrane from exposure to chlorine, which would irreparably damage the membrane.

Stage 4: Reverse Osmosis Membrane

Replace every 12 months

The fourth stage is the reverse osmosis membrane, which is the heart of the RO system. The RO membrane substantially reduces the total dissolved solids (TDS) from the water, including arsenic, barium, cadmium, chromium (hexavalent), chromium (trivalent), copper, turbidity, fluoride, lead, radium 226/228, and selenium, while washing the rejected contaminants down the drain. The treated water is directed to the storage tank.

Stage 5: Post Carbon Filter

Replace every 3-6 months

The last stage of filtration occurs as the water flows from the storage tank directly before being dispensed from the faucet. The in-line carbon post filter (also known as polishing filter) removes any remaining tastes or odors from the water, improving the flavor.

⚠ Notice: *Replacement frequency varies based upon incoming water quality and use patterns. Generally speaking, filters should be changed when there is a loss of performance or after an extended period of non-use.*

System On/Off Valves

Your RO System is equipped with two on/off ball valves. The system feed valve (to be installed into the cold water supply line) can be used to turn the water to the system on and off for maintenance without disrupting the water supply to the sink. The tank valve can also be closed to prevent water in the tank from draining out during maintenance. Both can be opened by turning counterclockwise, and closed by turning clockwise.



Table of Contents

About Your RO Water Treatment System	1
5 Stages of Water Treatment	1
System On/Off Valves.....	1
Conditions for Operation	3
Warnings	3
System Flow Diagram	4
Preparing For Installation	5
Recommended Tool List:	5
Check Location	5
Assemble Filter Housings onto System Manifold.....	5
Prepare Tubing	6
Quick Connect Fittings and Tubing Connections	6
<u>Installation Steps</u>	
Step 1 - Drill a Hole into the Sink for the Faucet	7
Step 2 - Faucet Installation	8
Step 3 - Drain Saddle Installation	9
Step 4 – System Feed Line Installation	10
Step 5 – Installing the RO Storage Tank	12
Additional Point of Use Connection (Optional)	12
System Mounting	13
Turning the System On for the First Time	13
Replacement Parts	14
System Maintenance	15
Membrane Replacement Instructions	15
Filter Replacement Instructions.....	15
Sanitizing.....	15
Troubleshooting Chart	16
Maintenance Schedule and Log	20

Conditions for Operation

Source Water Supply	
Community/Private	Non-Chlorinated – or chlorinated as long as the carbon filter is in place and replaced every 6 months. Chlorine will damage membranes if not removed properly.
System Pressure	40 psi minimum - 90 psi maximum
Temperature	4°-38° C (40°-100° F)
Maximum Supply TDS Level	1500 ppm (mg/L)
Turbidity	<1.0 Net Turbidity (NTU)

Chemical Parameters	
Hardness (CaCO ₃)	<175 mg/L (<10 gpg)*
Iron (Fe)	<0.1 mg/L
Manganese (Mn)	<0.05 mg/L
Hydrogen Sulfide (H ₂ S)	0.00 mg/L
Chlorine (CL ₂)	0.00 mg/L
pH	4 to 11

*Note that system may operate with higher hardness levels, but the membrane life will be reduced. Use of a water softener for hard water supplies will increase membrane life and efficiency.

Warnings



- Only use this system on potable water supplies. Do not use this system where the water is microbiologically unsafe or of unknown quality.
- Never use hot water or allow the unit to freeze.
- Incorrect installation or operation will void the warranty.
- Excessive incoming water pressure can cause leaks, flooding and property damage. It is highly recommended to monitor your home's incoming water pressure over a period of 24 hours to determine if a pressure regulator is required.
- Manufacturer assumes no responsibility for damages incurred through improper installation or use of these products.
- Ensure that all tubing and fittings used for RO product water are poly material, and not copper. Due to RO product water being very pure, it can leach the minerals from copper tubing which will cause a metallic taste in the water or ice and cause the copper tubing to develop pinhole leaks over time.

System Flow Diagram

A	Water supply to the first housing	J	Faucet
B	Water supply to the second housing	1	Clean Water Outlet
C	Water supply to the third housing	2	Pollutants Outlet
D	Housing with the RO Membrane	3	Water Supply to the 4-way valve from the elbow connector "OUT" in the third housing
E	Four-way Valve	4	Clean water supply to the 4-way valve through the membrane
F	In-Line Cartridge with Activated Carbon	5	Water outlet from the valve to the membrane
G	Flow Restrictor	6	Clean water outlet from the valve to the in-line cartridge with activated carbon
H	Tank Valve		
I	Tank		

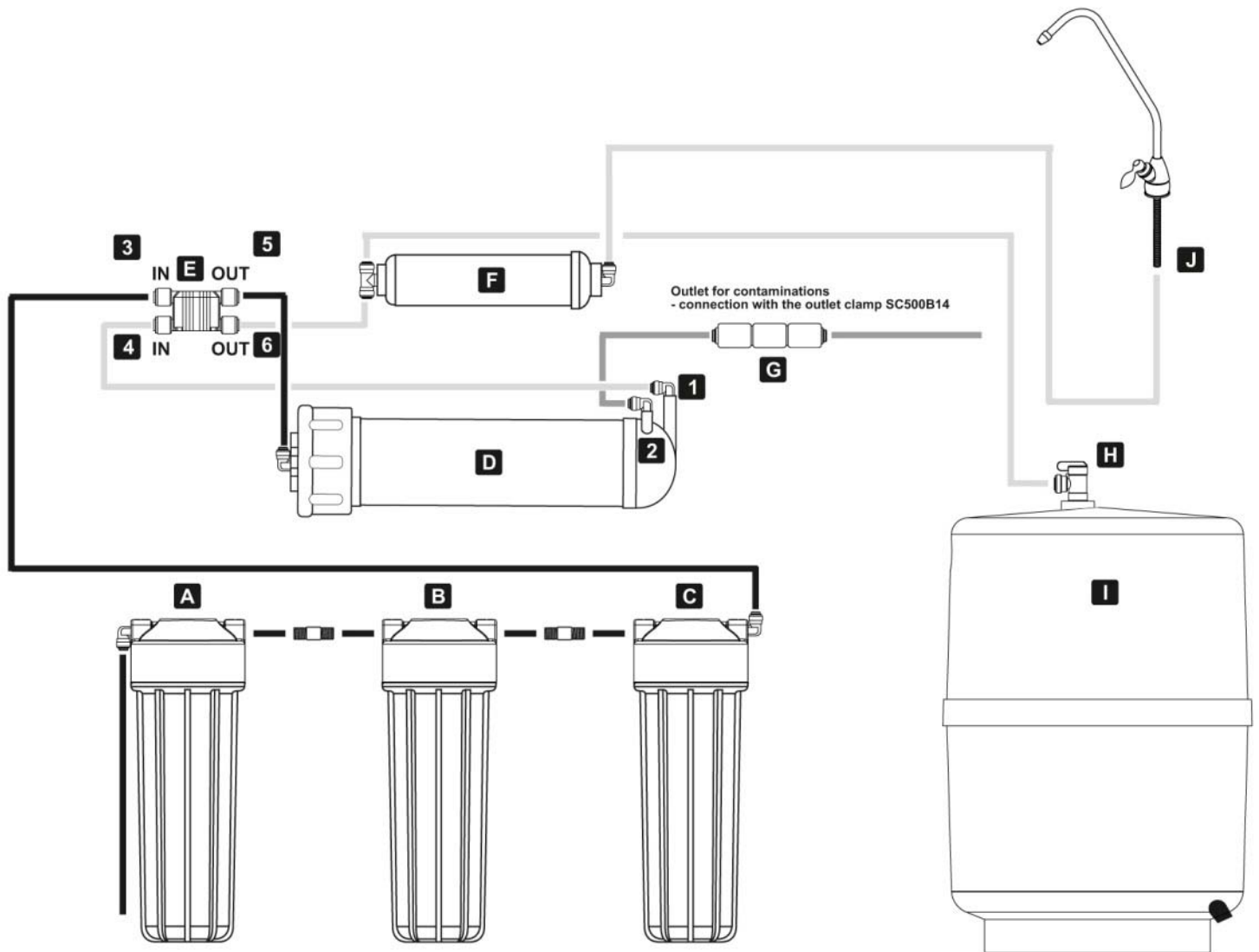

Preparing For Installation

Check the following list of components to ensure that all parts are packed with your system.

 RO System Manifold Assembly	 Filter Housing Sumps	 Filter Cartridges (Packed in Sumps)	 Storage Tank	 Faucet Kit
 Drain Saddle	 Feed Adapter Kit (1/2" & 3/8")	 Tank Valve	 Filter Wrench Membrane Wrench	 White Tubing

Recommended Tool List:

Have the below tools on hand before beginning installation. These are not included with the system.

- Electric drill with 1/8", 1/4" & 7/16" drill bits
- 1-1/4" hole saw bit for faucet opening – appropriate for the surface you are drilling
- 1/2" and 7/16" open-end wrenches (or two adjustable wrenches)
- Mounting screws or anchors appropriate for the surface you are mounting to
- Phillips screwdriver
- Utility knife
- Teflon tape (included)
- Masking tape or duct tape

Check Location

- Determine the location for the installation of the RO system. Avoid locations where the system might come in contact with hot water pipes or other hazards.
- Determine the location of the cold water feed line to use for the system supply.



Notice:

Accidentally hooking up the system to the hot water supply line will permanently damage the membrane (see conditions for operation). To assure you are using the cold water line, turn on both the hot and cold faucet. After the water is warm to the touch, feel the pipes under the sink. It will be easy to identify the hot and cold pipes.

- Determine the location for the faucet. Check to see that drilling the faucet hole will not damage pipes or wires running underneath the sink.
- Determine the location for the storage tank. A maximum distance from tank to faucet of 15 feet is possible (additional tubing will be needed). The system will produce a faster flow at the faucet with the shortest tubing run from tank to faucet.

Assemble Filter Housings onto System Manifold

- Remove the plastic wrapping from the filter cartridges and insert each cartridge into a filter sump.
- Making sure the o-ring stays seated properly, screw the filter sump onto the appropriate cap. The filters should be installed in the following order of flow (left to right):
(1) Sediment Filter H-F1005CF → (2) Carbon Filter H-F2510AC → (3) Carbon Filter H-F2510AC
- Check to ensure the sump is tightly threaded onto the housing.

Prepare Tubing

- When cutting tube lengths, it is important to ensure the system is accessible for maintenance. During installation and measuring, it is recommended to complete all of the tubing connections to the system with the system in front of the cabinet (before mounting) to allow enough slack for easy removal of the system for easier maintenance.
- Measure and cut (4) lengths of tubing in the appropriate lengths for:
 - ➊ Feed line to system pre-filter inlet
 - ➋ Post filter inlet (tee) to tank
 - ➌ Post filter outlet (elbow) to faucet
 - ➍ Membrane outlet flow restrictor to drain

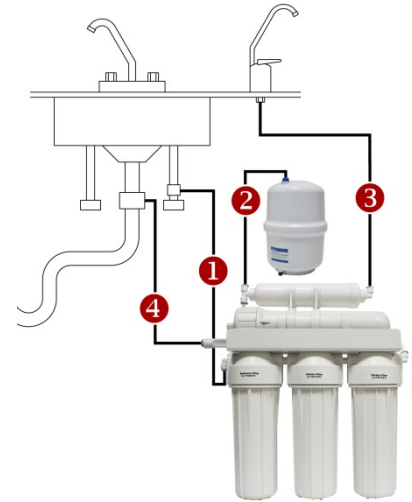

Quick Connect Fittings and Tubing Connections

To ensure a secure seal using quick connect fittings:

- **Cut tubing** with the end square. An angled cut or distortion of the tubing will not provide an efficient seal and may cause leaks.
- **Remove blue locking clip** from fitting before installing tubing. Push down on the fitting collet and remove the plug. Keep the clip. The plug may be discarded.
- **Push the tubing into the fitting**, to the pipe stop. The collet (gripper) has teeth which hold the tubing firmly in position while the 'O' Ring provides a permanent leak proof seal.
- **Check the Seal:** Pull on the tubing to check it is secure. It is good practice to test the system prior to leaving site and/or before use.
- **Replace blue locking clip** after tubing is installed.
- **To Disconnect:** Ensure system is depressurized before removing fittings. Push in the collet against the face of the fitting. With the collet held in this position the tube can be removed. The fitting can then be re-used.



Step 1 - Drill a Hole into the Sink for the Faucet



Notice:

If your sink is equipped with a pre-drilled 1 ¼" or 1 ½" hole suitable for the faucet installation, you may skip to step 2.



Notice:

Manufacturer assumes no responsibility for damages resulting from installing faucets into any surface. It is recommended to use a licensed contractor for this step.

For this, step, you will need:

- Masking tape or duct tape
- Variable speed drill with ⅛" and 7/16" drill bits
- 1-¼" hole saw bit for faucet opening – appropriate for the surface you are drilling

Determine the desired location for your RO Faucet

The product water faucet may be installed on any flat surface at least 2" in diameter. Check the underside of the location for interference. The standard faucet that is supplied with the system requires a ½" diameter hole. The optional air-gap faucet requires a larger hole of ¾" to allow for the additional tubing connections required.

Stainless Steel Sinks

Begin by placing a piece of masking tape or duct tape on the determined location where the hole is to be drilled. Make a small indent to mark the desired drilling location using a center punch. Drill a pilot hole with a ⅛" metal drill bit. Enlarge the hole using a ¼" metal drill bit, using factory approved method or approved plumbing practice.

Porcelain/Enamel Sinks or Tile Countertop

Sinks of this type are very easy to damage due to the nature of the materials of construction. A successful installation into these sinks requires a knowledgeable technician with the proper cutting tools. We strongly recommend the use of a "Relton" type device. Follow the directions that accompany the tool carefully.

Step 2 - Faucet Installation

For this step, you will need:

- Faucet assembly kit included with System
- Tubing, cut to the appropriate length
- Wrench

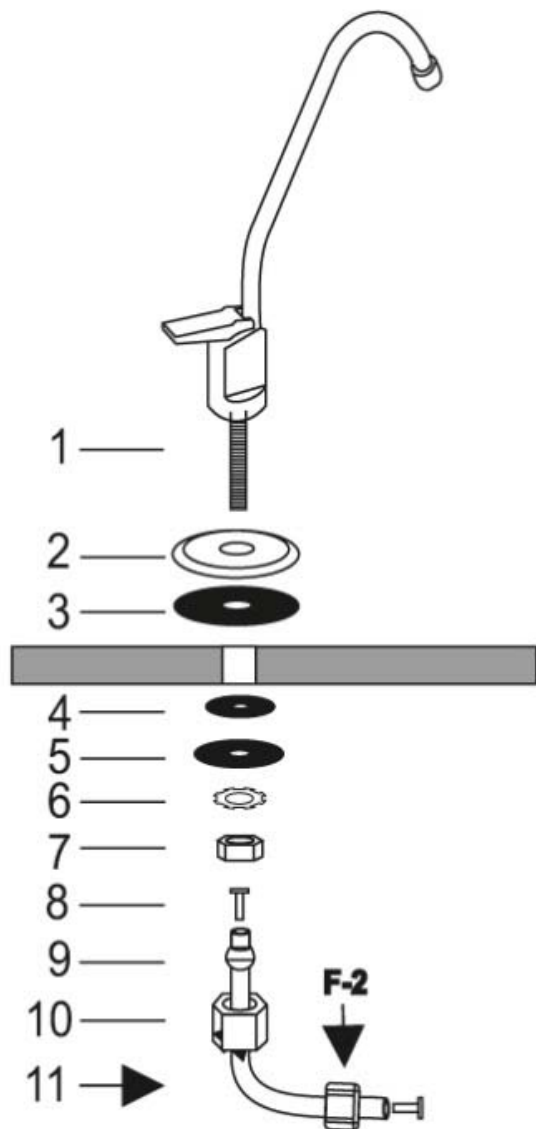

Install the faucet onto the countertop/sink:

- Find and identify all of the parts in the faucet bag, as shown in the diagram.
- Add the metal washer (2), and then the rubber seal (3) onto the threaded nozzle of the faucet (1).
- Place the faucet nozzle through the previously drilled hole in the countertop or sink top, and let it rest on the sink top.
- From the underside of the sink, slide the washers onto the threaded stem as shown in the diagram.
 - (4) & (5) - made of rubber
 - (6) - made of metal
- Secure the assembly by threading on the locking nut (7).
- Check the orientation and alignment of the faucet and washers, adjust as necessary, then use a wrench to tighten the locking nut securely

⚠ Notice: Do not overtighten fittings.

Install the Tubing

- Slide the metal nut (10) over the end of the tubing with the threads facing up.
- Add the plastic clamp (9).
- Press the plastic insert (8) into the end of the tubing.
- Slide the tubing (until it stops) inside the faucet nozzle and screw it in by hand with the nut that was placed on the tubing earlier (10).
- Connect the other end of the tubing to the elbow in the "out" end of the post filter.



Step 3 - Drain Saddle Installation

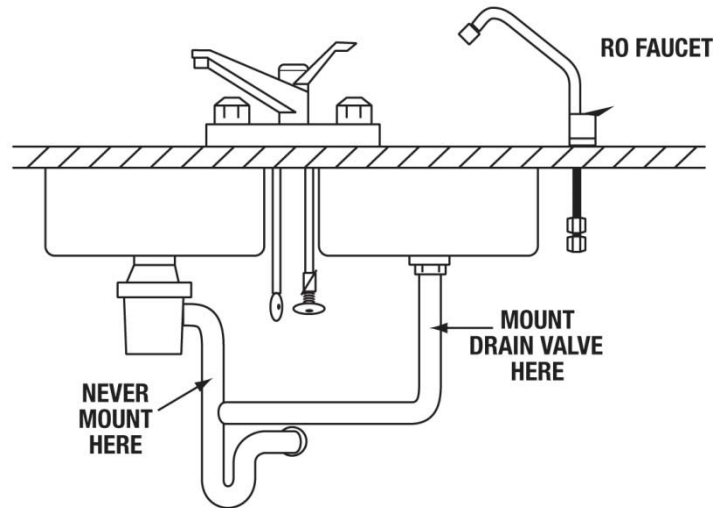

Notice:

Some states require the use of an air gap faucet. Check your local plumbing code to assure compliance.

For this step you will need:

- Masking tape or duct tape
- Variable speed drill w/ 1/8" and 1/4" drill bits
- Phillips Screwdriver
- Drain saddle assembly supplied with system
- White tubing cut to appropriate length

Select Location for Drain Saddle Installation

Select a location for the drain hole based on the design of the plumbing. It should be installed above the trap and on the vertical or horizontal tail piece.



Notice:

Do not install downstream of a garbage disposal, as this can cause contamination and system fouling. Install onto a drain location without a garbage disposal.

Drill a 1/4" Hole in the Drain Pipe

Starting with the 1/8" drill bit, drill a 1/8" hole in the drain pipe. Use the 1/4" drill bit to enlarge the hole. Clean the debris from the pipe and the hole before continuing.



⚠ Notice: Take extreme caution to not drill through to the other side of the drain pipe.

Install the Drain Clamp

- Apply the foam gasket inside the front half of the drain saddle: Punch out the cut-out hole in the center of the pad, remove the adhesive backing, and adhere to the inside of the drain saddle, ensuring the holes are aligned.
- Place one half of the plastic drain saddle assembly on each side of the drain pipe with the fitting, and clamp loosely using the nuts and bolts included.
- Align the hole drilled in the drain pipe with the hole in the drain saddle. A drill bit or other long narrow object may be used to help align correctly.
- Use Phillips screwdriver to tighten the clamp. Avoid over-tightening.

Connect Drain Line to RO System Reject Line

- Insert tubing to the pipe stop in the quick connect fitting on the drain line and check the seal.
- Connect the other end of the tubing to the flow restrictor outlet coming from the membrane brine port.

Step 4 – System Feed Line Installation

For this step you will need:

- 1/2" and 7/16" open-end wrenches (or two adjustable wrenches)
- Teflon Tape
- Feed Adapter (in the size that matches your feed line) & Ball Valve Kit
- Tubing

Locate and Turn Off the Cold Water Supply

- Locate the valve in the cold water feed line you use for the supply.





Notice:

Accidentally hooking up the system to the hot water supply line will permanently damage the membrane (see conditions for operation). To assure you are using the cold water line, turn on both the hot and cold faucet. After the water is warm to the touch, feel the pipes under the sink. It will be easy to identify the hot and cold pipes.

- Close the cold water valve.
- Turn on the sink faucet to drain water and relieve pressure from the lines.
- If no shut off valve is located under the sink, or if water continues to come out of the faucet, turn off the main supply at the entry to the house, then turn on the sink faucet to drain water and relieve pressure from the lines.

Assemble the Ball Valve & Adapter Kit

- Identify your line size and use the appropriate feed adapter (3/8" or 1/2"). The extra feed adapter is not needed.
- Use Teflon tape to wrap the threads of the ball valve – approximately 3 wraps.
- Screw the ball valve into the adapter.

Install the Feed Adapter into the Cold Water Supply

- Wrap the slip joint adapter with Teflon tape, approximately 3 wraps.
- **For Flex Line:** Loosen nut and separate cold water riser tube from faucet shank. Gently bend riser tube so that slip joint fits onto faucet shank. Make sure the flat washer is on top and the cone washer is on the bottom. Reinstall riser tubes onto slip joint adapter and tighten.
- **For Solid Copper Riser Tube:** Same procedure as flex tubing except you must cut a piece of the riser tube about 3/4" to 1" so the slip joint adapter can fit between faucet and riser tube.



Connect the Feed Line Tubing

- Unscrew the nut from the ball valve. Slide the nut onto the tubing, threaded sides facing the end of the tubing. Feed the nipple on the ball valve into the tubing, pushing the tubing until it slides over the lip. Slide the nut to the threads on the ball valve, and tighten the nut down over the tubing. Use a wrench to tighten 1/4 turn past finger-tight.
- Connect the other end of the tubing to the feed port on the RO System.

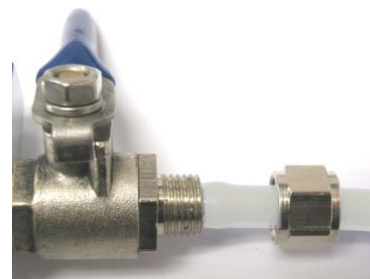
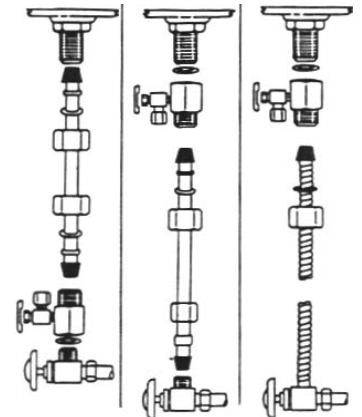

Step 5 – Installing the RO Storage Tank

For this step you will need:

- Storage Tank
- Tank Valve
- Tubing



Notice:

Do not tamper with the air valve on the low side of the storage tank. It has been factory charged to 8psi and covered with a black cap.

Install the Tank Valve & Tubing

- Remove the blue cap on top of the tank to expose the threaded in/out connection. Connect the tank ball valve by threading onto the fitting. Do not over-tighten.



Notice:

Do not add teflon tape to the tank fitting. This will prevent seals from engaging and may cause leaking.

- Insert the tubing into the quick connect fitting on the ball valve.
- Connect the other end of the tubing to the inlet tee of the post-carbon filter on the RO system.

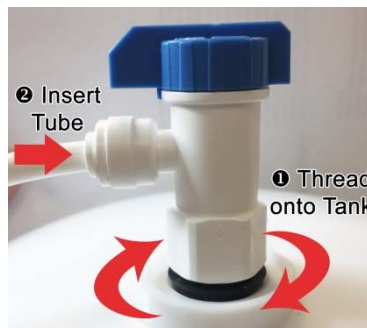

Additional Point of Use Connection (Optional)



Notice:

Ensure that all tubing and fittings used for RO product water are poly material, and not copper. Due to RO product water being very pure, it can leach the minerals from copper tubing which will cause a metallic taste in the water or ice and cause the copper tubing to develop pinhole leaks over time.

An additional connection may be made to other equipment such as an icemaker, refrigerator, coffeemaker, or other equipment. This requires an additional tee fitting and extra tubing. It is also strongly recommended to install an in-line ball valve between the RO system and the equipment, to be closed during startup and maintenance.

Suggested Parts

1/4" Union Tee



Part Number: PI0208S

1/4" Tubing (10 Feet)



Part Number: TUBE-10FT-14-WH

1/4" In-Line Ball Valve



Part Number: PPSV040808W

Installation

- Cut tubing between the faucet and the outlet of the post-filter. Insert the line into both branches of the tee.
- Run line from the stem of the tee to the equipment and connect according to manufacturer's instructions.
- Install the ball valve in an accessible location on the line by cutting the line and inserting the tubing into both sides of the ball valve.

System Mounting

Wall mounting is recommended for this system. Dry wall anchors and screws may be necessary (not included with the system).

- Mark screw locations at the desired positions. Use the two holes on the back of the RO System mounting bracket for marker guides.
- Screw the screws into the mounting wall on the marked positions. Use an anchoring device appropriate for the type of material you are screwing into.
- Hang the purification system onto the screws by the holes on the back of the unit.

Turning the System On for the First Time

Make sure all water supply and drain line connections are secure and free from leaks.

Slowly turn the feed valve counterclockwise until fully open (the handle should be in line with the tubing as it enters the connection). Check the stem seal for leakage. If necessary, tighten stem nut lightly.

Turn storage tank valve one quarter turn counterclockwise to open the valve (the handle should be in line with the tubing as it enters the connection).

Open the product water faucet and let the water flow until all the air has been expelled from the system. This will take about an hour.

Close the product water faucet. In 30 minutes, check the system and connections for leaks and correct if necessary.



Do Not Use the First Two Reservoirs of Water

Allow the reservoir to fill for 4-6 hours. Dispense this water to drain. This process removes the factory installed sanitizing solution from the entire system and sends it to the drain. Repeat this process one more time. Allow the tank to fill for 4-6 hours and dispense this water to the drain. Do not drink this water!



Notice:





Air bubbles may be present in the product water after initial system startup, causing a milky color in the water. This is normal and safe to drink. The air bubbles will disappear within a few days of regular use.





Notice:

Check back frequently in the first 24 hours to ensure no leaking has occurred.

Replacement Parts

<p>Sediment Pre-Filter, 5 Micron. Stage 1</p> <p>Model: H-F1005CF Qty. 1 Per System <i>Replace every 3-6 months</i></p> 	<p>Carbon Pre-Filter, Extruded Carbon Stage 2 & 3</p> <p>Model: H-F2510AC Qty. 2 Per System <i>Replace every 3-6 months</i></p> 	<p>Replacement Filter Kits:</p>  <p>RFK-5: Pre & Post Filters RFK-5-PRE: Pre-Filters Only</p> <p>RFK-5-50 (50 gpd) RFK-5-100 (100 gpd) One complete set of prefilters, post filter, and membrane. <i>See back cover for replace schedule.</i></p>
<p>Membrane Element Stage 4</p> <p>Model: 50 GPD: M-T1812A50 100 GPD: M-T1812A100 Qty. 1 Per System <i>Replace every 12 months</i></p> 	<p>Carbon Post-Filter, GAC Inline Stage 5</p> <p>Model: H-F10GAC-14 Qty. 1 Per System <i>Replace every 3-6 months</i></p> 	

Other Replacement Components

Part	Image	Part	Image
<p>H-H14FWWA Filter Housing Standard 10" White, 1/4" FNPT</p> 	<p>H-T5000 Faucet, Non-Airgap, Long-Reach</p> 	<p>TUBE-10FT-14-WH White Tubing 10 foot pack</p> 	
<p>PV2012PME Membrane Housing 1/8" FNPT</p> 	<p>H-V1050W-QC Auto Shut-Off Valve</p> 	<p>PN-4-P 1/4" Hex Nipple (connects filter housing to filter housing)</p> 	
<p>H-S3200PW Storage Tank 3.2 gallon</p> 	<p>H-S3200TV Tank Shut-Off Valve</p> 	<p>F-4MBT44QC 1/4" Male to 1/4" QC Branch Tee (for post filter inlet)</p> 	
<p>H-R2068QC 50 GPD Flow Restrictor</p> <p>H-R1000QC 100 GPD Flow Restrictor</p> 	<p>H-V1009 Feed Valve and Adapter</p> 	<p>PI480822S Elbow Fitting 1/4" MNPT x 1/4" QC (for filter housings & post filter outlet)</p> 	
<p>H-J2021KW Clip, Membrane Housing to In-line Filter</p> 	<p>H-D3000M Drain Saddle</p> 	<p>PI480821S Elbow Fitting 1/8" MNPT x 1/4" QC (for membrane housing)</p> 	
<p>H-J2025PW Clip, Membrane Housing to Bracket</p> 	<p>H-C9200FWWA Wrench for Filter Housing</p> 	<p>H-V1003 Check Valve, installed in 1/4" Elbow (membrane permeate)</p> 	
	<p>OR-H10FWWA-SET O-Ring Set for Filter Housing. Top & Bottom.</p> 	<p>H-B2031W Mounting Bracket</p> 	

System Maintenance



Notice:

If your RO system is connected to an icemaker or other equipment, you must turn off the connection to the equipment before performing any maintenance.

Membrane Replacement Instructions

The membrane should be replaced every 1-2 years, depending on the water quality.

Before starting, shut off the cold water supply to the unit. Lift the handle on the faucet to drain out the storage tank completely and allow the system to stand for 10 minutes in order to fully decompress the tank. Leave the faucet open until the membrane change is complete.

1. Unscrew the fitting to the cap of the membrane housing. Use the membrane wrench if the cap is too tight.
2. Using pliers, pull out the old membrane from the housing.
3. Remove the new membrane from its bag.
4. Insert the membrane in the housing in the same direction as the old membrane.
5. Push the membrane firmly into the housing until it seats on the far end.
6. Screw the housing cap back on, making sure the o-ring is positioned correctly.
7. Screw the fitting (with tubing) back onto the housing.
8. The system is ready. Turn on the water supply. Check for any leaks.
9. Drain the first two tanks of water before drinking.

Filter Replacement Instructions

All pre and post-filters should be replaced every 3-6 months.

Before starting, shut off cold water supply to unit. Lift the handle on the faucet to drain out the storage tank completely and allow the system to stand for 10 minutes in order to fully decompress the tank, reserving some of the RO water to use to rinse the filter housings. Leave the faucet open until the filter change is complete.

1. Remove pre-filters from filter housings. Use a filter wrench if the housings are too tight.
2. Discard used filters, but save o-rings for re-use.
3. Clean inside of all housings with a mild soap solution, and then rinse with RO water.
4. Lubricate the o-ring and replace in filter housing.
5. Insert the new filters into the appropriate housings and replace the housings onto the system.
6. Disconnect the post-filter by removing the fittings on either end. Replace with new post-filter and re-use the existing fittings. *(Feed end tee is connected by a short length of tubing, remove this and use to connect to new filter.)*
7. Follow the normal Start-up Procedures. (Drain the first tank of water after changing the filters before drinking.)

Sanitizing

We recommend sanitizing the system at least once a year. This can be done while changing your filters. Shut down the system. If you have an icemaker hook-up installed, be sure the ball valve in the line to the refrigerator is in the closed position during this procedure. Open the faucet to drain the system, including the tank. Remove the pre-filter cartridges and RO Membrane from the system, leaving the old post-filter cartridge in place. Wash the internal filter housing & membrane housing areas with warm soapy water and rinse well to remove the soap. Pour about ¼ teaspoon of Hydrogen Peroxide or household bleach into each filter housing and replace housings on the RO system. Open the feed water valve and open the RO faucet until water flows freely from the spout. Close the faucet and hold the solution in the system for a minimum of 10 minutes.

Drain the tank completely, close the faucet to allow tank to fill again, and then drain again. Replace filters and membrane as indicated in the replacement instructions. The post filter should be changed after sanitizing the system.

Troubleshooting Chart

Symptom	Possible Cause	Remedy
No water in the storage tank	Filter Cartridges have failed.	Replace filter cartridges as indicated in maintenance section.
	Cartridges are out of sequence.	Install cartridges in proper sequence as indicated in system components.
	Cartridges are upside-down.	Install carbon block filter right-side-up as indicated on the filter.
	No pressure in storage tank.	Check pressure with pressure gauge. Refill or reduce pressure to max 8 psi. Note: Tank must be empty of water when checking the air pressure.
	Automatic shut-off valve malfunctioning.	Check lines to valve for correct hook-up and check water running into the drain. Replace if necessary.
	Kinked lines.	Straighten lines if necessary.
Getting low flow	Incoming water pressure too low.	Check source of feedwater (city water, well water, etc.) for pressure. A booster pump may be required.
	Change in feedwater temperature.	The reverse osmosis membrane used in your unit is rated at 77°F and 60psi. Water production will decrease approximately 1.5% for each degree that your incoming water is below 77°F. It may be necessary to change to a higher flow membrane (and flow restrictor).
	Storage tank pressure is too low.	Check pressure with gauge and refill to maximum 8 psi. Note: Tank must be empty of water when checking the air pressure.
	Filters are clogged.	Replace Filters.
Water leakage at filter bowls	Filter bowls are loose.	Retighten.
	Burr on edge of filter bowl.	Remove burr with emery cloth or sand paper.
	O-Ring in filter bowls is missing, damaged, or not sealed properly	Replace or position correctly.
Water backing up to air gap in faucet (Systems w/ air gap faucets only)	Line is clogged.	Clean out the line.
	Line is too long.	Must be as short and straight as possible.
	Drain line is clogged.	Disconnect 3/8" dia. Line and clean out with probe or by flushing.
Faucet spout is dripping	Handle sticking or worn.	Replace the faucet
Milky colored water	Air in the system	Air in the system is normal after startup of the RO. Water should lose the milky look within a few days of normal usage.

PRODUCT WARRANTY

- SELLER hereby warrants to CUSTOMER that the goods herein described will be free from any liens or encumbrances, that good title to said goods will be conveyed to CUSTOMER by sale of same.

SELLER warrants materials of its own manufacture against defects in material and workmanship under normal conditions of usage and service as specified in this manual for one year from whichever of the following events occur first:

- First use of the system
- Three (3) months following date of shipment from Vista, CA.

Materials not manufactured by SELLER receive only such warranty, if any, of the manufacturer thereof and which are hereby assigned to CUSTOMER without recourse to SELLER.

SELLER'S obligation under this warranty is limited to and shall be fully discharged by repairing or replacing any defective part FOB its works. SELLER shall not be liable for repair or alterations made without SELLER'S prior written approval; for membrane elements becoming plugged by suspended matter, precipitates, or biological growth; or for failure to properly maintain the element. SELLER shall not be liable for damages or delay caused by defective material. Products returned to SELLER for warranty examination must be shipped freight prepaid.

- **SELLER'S Liability.** SELLER SHALL NOT BE LIABLE FOR PROSPECTIVE PROFITS OR SPECIAL, INDIRECT OR CONSEQUENTIAL DAMAGES, NOR SHALL RECOVERY OF ANY KIND AGAINST SELLER BE GREATER IN AMOUNT THAT THE PURCHASE PRICE OF THE SPECIFIC GOODS SOLD AND CAUSING THE ALLEGED DAMAGE, WHETHER SUCH CLAIM BE BASED ON CONTRACT OR TORT; provided, however, the aforesaid to the contrary notwithstanding, SELLER shall not be liable for any bodily injuries or property damage directly caused by its willful, wanton or negligent acts.
- **All Other Warranties and Damages.** THERE ARE NO WARRANTIES ESTABLISHED, EXPRESS OR IMPLIED OR STATURTORY, INCLUDING THE WARRANTY OF MERCHANTABILITY, EXCEPT THOSE SET FORTH ABOVE OR ANY PERFORMANCE WARRANTY WHICH IS ATTACHED TO THIS ORDER.
- **Permits, Ordinances and Code Compliance.** CUSTOMER has full responsibility for obtaining any licenses, permits and inspections required with respect to installation and use of the goods herein described.
- **Governing Law.** Any agreement based upon this Order and the obligations thereby imposed on SELLER and CUSTOMER shall be governed by and construed according to the laws of the State of California.

Replacement Schedule

Our recommended replacement schedule is for average feed water quality. For cleaner city water, a lower frequency schedule may be sufficient. For applications where the feed water is dirtier or has specific issues, more frequent change-outs may be required. Generally speaking, filters should be changed when there is a loss of performance and after any extended periods of non-use.

Record Installation Date:

3 Month Replacements	6 Month Replacements	9 Month Replacements	1-Year Replacements
Filter Pack: RFK-5-PRE	Filter Pack: RFK-5	Filter Pack: RFK-5-PRE	Filter Pack: RFK-5-50/100
<ul style="list-style-type: none"> ◆ Sediment Pre-filter ◆ Carbon Pre-filter (x 2) 	<ul style="list-style-type: none"> ◆ Sediment Pre-filter ◆ Carbon Pre-filter (x 2) ◆ Carbon Post-Filter 	<ul style="list-style-type: none"> ◆ Sediment Pre-filter ◆ Carbon Pre-filter (x 2) 	<ul style="list-style-type: none"> ◆ Sediment Pre-filter ◆ Carbon Pre-filter (x 2) ◆ Carbon Post-Filter ◆ RO Membrane ◆ (Sanitize System)

Replacement Records		
	Replaced on	
3-Month:		
6-Month:		
9-Month:		
1 Year:		
3-Month:		
6-Month:		
9-Month:		
1 Year:		
3-Month:		
6-Month:		
9-Month:		
1 Year:		
3-Month:		
6-Month:		
9-Month:		
1 Year:		
3-Month:		
6-Month:		
9-Month:		
1 Year:		

Filter Packs (Order on wateranywhere.com)

RFK-5 – Replacement Filter-Pack

(Membrane Sold Separately) *Includes:*

- ◆ (1) H-F1005CF – 5 Micron Sediment Prefilter (Stage 1)
- ◆ (2) H-F2510AC – Carbon Block Pre-filters (Stages 2 & 3)
- ◆ (1) H-F10GAC-14 – Carbon Post-Filter (Stage 5)



RFK-5-PRE – Half-Year Pre-Filter-Pack

(Membrane Sold Separately) *Includes:*

- ◆ (1) H-F1005CF – 5 Micron Sediment Prefilter (Stage 1)
- ◆ (2) H-F2510AC – Carbon Block Pre-filters (Stages 2 & 3)



RFK-5-50 – Replacement Membrane & Filter Pack

With 50 GPD Membrane - *Includes:*

- ◆ (1) H-F1005CF – 5 Micron Sediment Prefilter (Stage 1)
- ◆ (2) H-F2510AC – Carbon Block Pre-filters (Stages 2 & 3)
- ◆ (1) M-T1812A50 – 50 GPD Reverse Osmosis Membrane (Stage 4)
- ◆ (1) H-F10GAC-14 – Carbon Post-Filter (Stage 5)

RFK-5-100 – Replacement Membrane & Filter Pack

With 100 GPD Membrane - *Includes:*

- ◆ (1) H-F1005CF – 5 Micron Sediment Prefilter (Stage 1)
- ◆ (2) H-F2510AC – Carbon Block Pre-filters (Stages 2 & 3)
- ◆ (1) M-T1812A100 – 100 GPD Reverse Osmosis Membrane (Stage 4)
- ◆ (1) H-F10GAC-14 – Carbon Post-Filter (Stage 5)

